

AV45C Quarter-brick Series

Technical Reference Notes

1.5V, 1.8V, 3.3V, 5V Single Output

48V Input, 100W DC-DC Converter

(Rev01)

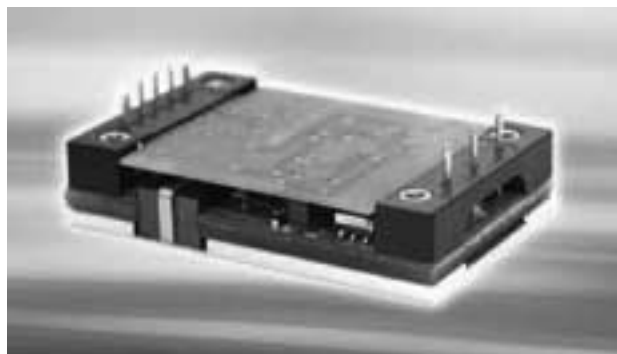

**AV45C Quarter-Brick Series 100W Power Converters
36Vdc to 75Vdc Input, Single Output**

Introduction

The AV45C quarter-brick series comes in a industry standard quarter-brick package of **1.45" x 2.28" x 0.5"** and footprint, and incorporates the super high efficiency up to 90%(@5Vout), and high power density up to 60.5W/in³. The input range is 36V-75V, and input is fully isolated from output and the isolation voltage is 1500Vdc.

The typical efficiencies are 90% for the 5V output, 89% for the 3.3V output, 85% for the 1.8V and 1.5V output.

Designed using a synchronous rectification topology, AV45C series incorporates simple structure, good electrical performance and high reliability. Standard features include input LVP, output OVP, OCP, short circuit protection, and over-temperature protection.

The AV45C quarter-brick series is designed to meet CISPR22, FCC Class A, UL, TUV, and CSA certifications.

Design Features

- ☞ High Efficiency
- ☞ High power density
- ☞ Low output noise
- ☞ Input under-voltage lockout
- ☞ CNT function
- ☞ Trim function
- ☞ Remote sense
- ☞ Output short circuit protection
- ☞ Output current limiting
- ☞ Output over-voltage protection
- ☞ Overtemperature protection
- ☞ High input-output isolation voltage

Options

- ☞ Heat sink available for extended operation.
- ☞ Choice of CNT logic configuration.

**AV45C Quarter-Brick Series 100W Power Converters
36Vdc to 75Vdc Input, Single Output**

Typical Application

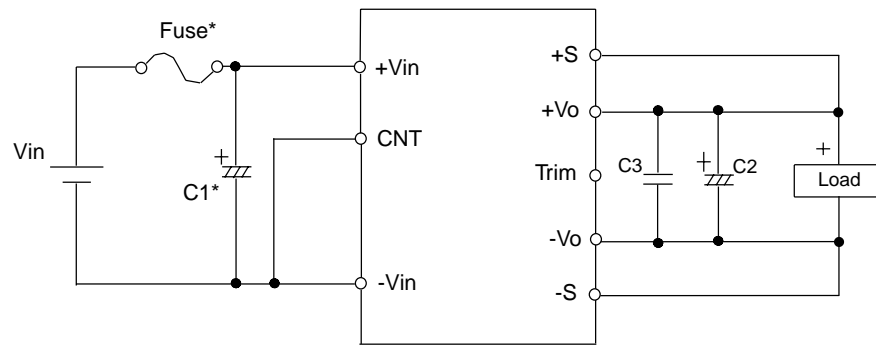

Fuse*: Use external fuse (fast blow type) for each unit.

5V output	10A (Pout=100W)
3.3V output	8A (Pout=66W)
1.8V output	5A (Pout=36W)
1.5V output	5A (Pout=30W)

C1*: Recommended input capacitor C1

-20 °C ~ +100 °C : 100 μ F/100V high frequency aluminum electrolytic capacitor for 1.5Vout & 1.8Vout

220 μ F/100V high frequency aluminum electrolytic capacitor for 3.3Vout & 5Vout

-40 °C ~ +100 °C : 220 μ F/100V high frequency aluminum electrolytic capacitor for 1.5Vout & 1.8Vout

470 μ F/100V high frequency aluminum electrolytic capacitor for 3.3Vout & 5Vout

C2*: Recommended output capacitor C2

-20 °C ~ +100 °C : 1000 μ F/10V (high frequency aluminum electrolytic capacitor)

-40 °C ~ +100 °C : for this temperature, use two pieces of 1000 μ F/10V capacitor in parallel or one 2200 μ F

high frequency aluminum electrolytic capacitor.

C3: Recommended 1 μ F/10V ceramic type capacitor

Note: The AV45C modules can not be used in parallel mode directly!!

There is no minimum load requirement for the AV45C series modules.

AV45C Quarter-Brick Series 100W Power Converters
36Vdc to 75Vdc Input, Single Output

Block Diagram

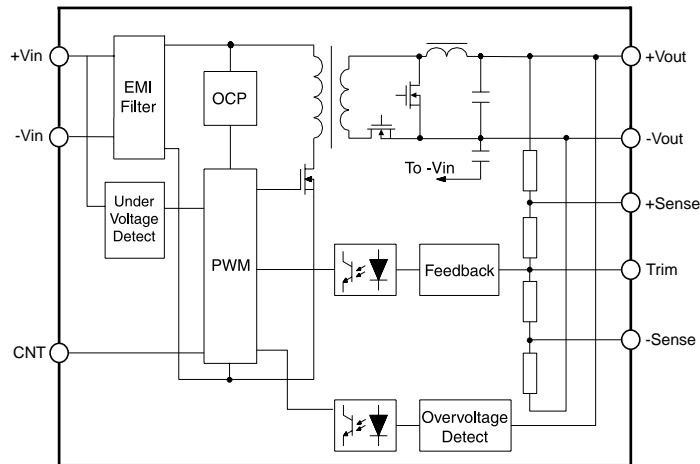

Ordering Information

Model Number	Input Current	Input Voltage	CNT Logic	Output Current	Ripple (mV p-p)	Noise (mV p-p)	Efficiency typ	Pin Length mm(inch)
AV45C-048L-050F20HA	3.3A	36-75V	Positive	20A	70	150	90%	4.80(0.189)
AV45C-048L-050F20HAN	3.3A	36-75V	Negative	20A	70	150	90%	4.80(0.189)
AV45C-048L-033F20HA	2.05A	36-75V	Positive	20A	70	150	89%	4.80(0.189)
AV45C-048L-033F20HAN	2.05A	36-75V	Negative	20A	70	150	89%	4.80(0.189)
AV45C-048L-018F20HA	1.25A	36-75V	Positive	20A	70	150	86%	4.80(0.189)
AV45C-048L-018F20HAN	1.25A	36-75V	Negative	20A	70	150	86%	4.80(0.189)
AV45C-048L-015F20HA	1.0A	36-75V	Positive	20A	70	150	85%	4.80(0.189)
AV45C-048L-015F20HAN	1.0A	36-75V	Negative	20A	70	150	85%	4.80(0.189)

**AV45C Quarter-Brick Series 100W Power Converters
36Vdc to 75Vdc Input, Single Output**

Absolute Maximum Rating

Characteristic	Min	Typ	Max	Units	Notes
Input Voltage(continuous)	-0.3		80	Vdc	
Input Voltage(peak/surge)	-0.3		100	Vdc	100ms non-repetitive
Operating case temperature	-40		100	°C	
storage temperature	-55		125	°C	

Input Characteristics

Characteristic	Min	Typ	Max	Units	Notes
Input Voltage Range	36	48	75	Vdc	
Input Reflected Current		10	15	mAp-p	
Turn-off Input Voltage	31	33		V	
Turn-on Input Voltage		34	36	V	
Turn On Time		20	35	ms	

CNT Function

Characteristic	Min	Typ	Max	Units	Notes
Logic High	3.5		15	Vdc	
Logic Low	-0.7		1.8	Vdc	
Control Current			2	mA	

General Specifications

Characteristic	Min	Typ	Max	Units	Notes
MTBF		2000		k Hrs	Bellcore TR332, Tcase=30°C
Isolation	1500			Vdc	
Pin solder temperature			260	°C	wave solder < 10 s
Hand Soldering Time			5	s	iron temperature 425°C
Weight		60		grams	

AV45C Quarter-Brick Series 100W Power Converters
36Vdc to 75Vdc Input, Single Output

AV45C-048L-050F20HA(N) Output Characteristics

Characteristic	Min	Typ	Max	Units	Notes
Power			100	W	
Output Current		20		A	
Output Setpoint Voltage	4.90	5.00	5.10	Vdc	Vin=48V, Io=20A
Line Regulation		0.02	0.2	%Vo	Vin=36~75V, Io=20A
Load Regulation		0.03	0.5	%Vo	Io=0~20A, Vin=48V
Dynamic Response					
50-75% load		1		%Vo	Ta=25°C, DI/Dt=1A/10µs
		100		µs	Ta=25°C, DI/Dt=1A/10µs
50-25% load		1		%Vo	Ta=25°C, DI/Dt=1A/10µs
		100		µs	Ta=25°C, DI/Dt=1A/10µs
Current Limit Threshold	22		28	A	
Short Circuit Current		27	30	A	
Efficiency		90		%	Vin=48V, Io=20A
Trim Range	80		110	%Vo	
Over Voltage Protection Setpoint	5.7		6.8	V	
Sense Compensation			0.5	V	
Temperature Regulation		0.003	0.02	%Vo/°C	
Ripple (p-p)		40	70	mV	(0 to 20MHz Bandwidth)
Noise (p-p)		100	150	mV	(0 to 20MHz Bandwidth)
Over Temperature Protection	100		115	°C	
Switching Frequency		250		kHz	

AV45C Quarter-Brick Series 100W Power Converters
36Vdc to 75Vdc Input, Single Output

AV45C-048L-033F20HA(N) Output Characteristics

Characteristic	Min	Typ	Max	Units	Notes
Power			66	W	
Output Current		20		A	
Output Setpoint Voltage	3.24	3.3	3.36	Vdc	Vin=48V, Io=20A
Line Regulation		0.02	0.2	%Vo	Vin=36~75V, Io=20A
Load Regulation		0.03	0.5	%Vo	Io=0~20A, Vin=48V
Dynamic Response					
50-75% load		2		%Vo	Ta=25°C, DI/Dt=1A/10µs
		100		µs	Ta=25°C, DI/Dt=1A/10µs
50-25% load		2		%Vo	Ta=25°C, DI/Dt=1A/10µs
		100		µs	Ta=25°C, DI/Dt=1A/10µs
Current Limit Threshold	22		28	A	
Short Circuit Current		27	30	A	
Efficiency		89		%	Vin=48V, Io=20A
Trim Range	80		110	%Vo	
Over Voltage Protection Setpoint	3.9		5.0	V	
Sense Compensation			0.5	V	
Temperature Regulation		0.003	0.02	%Vo/°C	
Ripple (p-p)		40	70	mV	(0 to 20MHz Bandwidth)
Noise (p-p)		100	150	mV	(0 to 20MHz Bandwidth)
Over Temperature Protection	100		115	°C	
Switching Frequency		250		kHz	

AV45C Quarter-Brick Series Power Converters
36 VDC to 75 VDC Input, 5V and 1.8V Output, 100 Watt Output

AV45C-048L-018F20HA(N) Output Characteristics

Characteristic	Min	Typ	Max	Units	Notes
Power			36	W	
Output Current		20		A	
Output Setpoint Voltage	1.77	1.80	1.83	Vdc	Vin=48V, Io=20A
Line Regulation		0.02	0.2	%Vo	Vin=36~75V, Io=20A
Load Regulation		0.1	0.5	%Vo	Io=0~20A, Vin=48V
Dynamic Response					
50-75% load		3		%Vo	Ta=25°C, DI/Dt=1A/10µs
		100		µs	Ta=25°C, DI/Dt=1A/10µs
50-25% load		3		%Vo	Ta=25°C, DI/Dt=1A/10µs
		100		µs	Ta=25°C, DI/Dt=1A/10µs
Current Limit Threshold	22		28	A	
Short Circuit Current		27	30	A	
Efficiency		86		%	Vin=48V, Io=20A
Trim Range	80		110	%Vo	
Over Voltage Protection Setpoint	2.2		2.8	V	
Sense Compensation			10	%Vo	
Temperature Regulation		0.003	0.02	%Vo/°C	
Ripple (p-p)		40	70	mV	(0 to 20MHz Bandwidth)
Noise (p-p)		100	150	mV	(0 to 20MHz Bandwidth)
Over Temperature Protection	100		115	°C	
Switching Frequency		250		kHz	

AV45C Quarter-Brick Series 100W Power Converters
36Vdc to 75Vdc Input, Single Output

AV45C-048L-015F20HA(N) Output Characteristics

Characteristic	Min	Typ	Max	Units	Notes
Power			30	W	
Output Current		20		A	
Output Setpoint Voltage	1.47	1.50	1.53	Vdc	Vin=48V, Io=20A
Line Regulation		0.02	0.2	%Vo	Vin=36~75V, Io=20A
Load Regulation		0.1	0.5	%Vo	Io=0~20A, Vin=48V
Dynamic Response					
50-75% load		3		%Vo	Ta=25°C, DI/Dt=1A/10µs
		100		µs	Ta=25°C, DI/Dt=1A/10µs
50-25% load		3		%Vo	Ta=25°C, DI/Dt=1A/10µs
		100		µs	Ta=25°C, DI/Dt=1A/10µs
Current Limit Threshold	22		28	A	
Short Circuit Current		27	30	A	
Efficiency		85		%	Vin=48V, Io=20A
Trim Range	80		110	%Vo	
Over Voltage Protection Setpoint	1.9		2.5	V	
Sense Compensation			10	%Vo	
Temperature Regulation		0.003	0.02	%Vo/°C	
Ripple (p-p)		40	70	mV	(0 to 20MHz Bandwidth)
Noise (p-p)		100	150	mV	(0 to 20MHz Bandwidth)
Over Temperature Protection	100		115	°C	
Switching Frequency		250		kHz	

AV45C Quarter-Brick Series 100W Power Converters
36Vdc to 75Vdc Input, Single Output

Characteristic Curves (at 25 °C)

Typical Efficiency AV45C-048L-050F20HAN

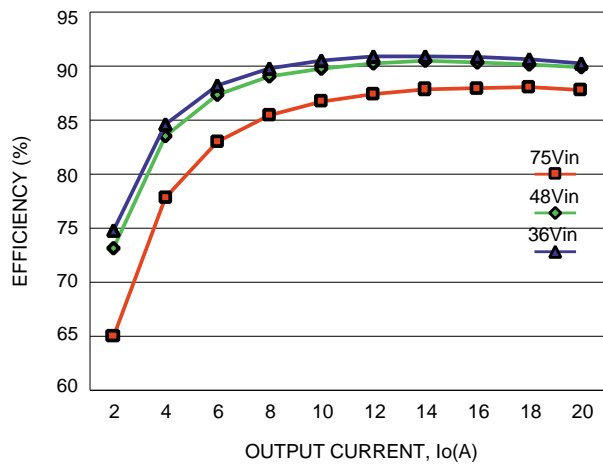

Typical Efficiency AV45C-048L-033F20HAN

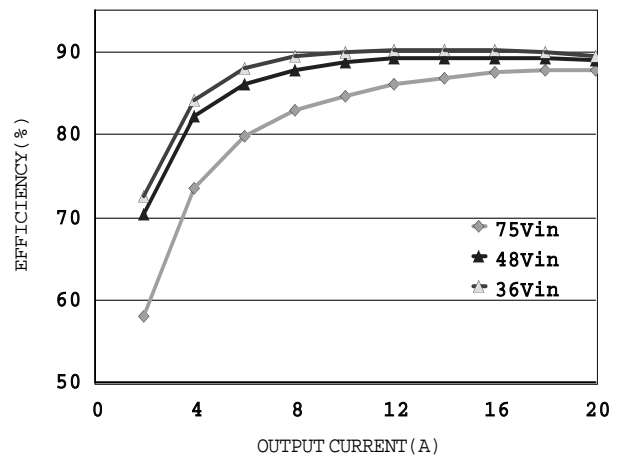

Typical Efficiency AV45C-048L-018F20HAN

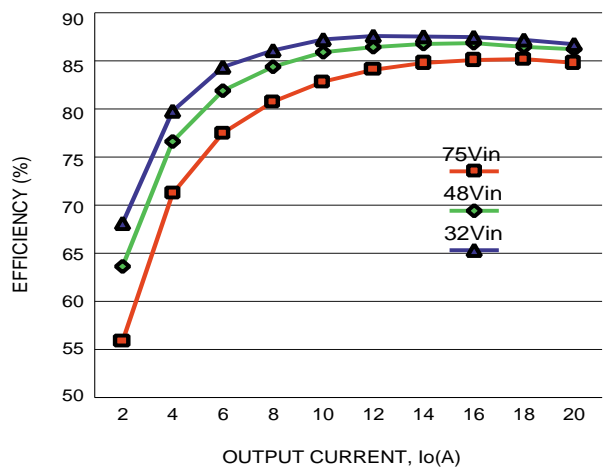

Typical Efficiency AV45C-048L-015F20HAN

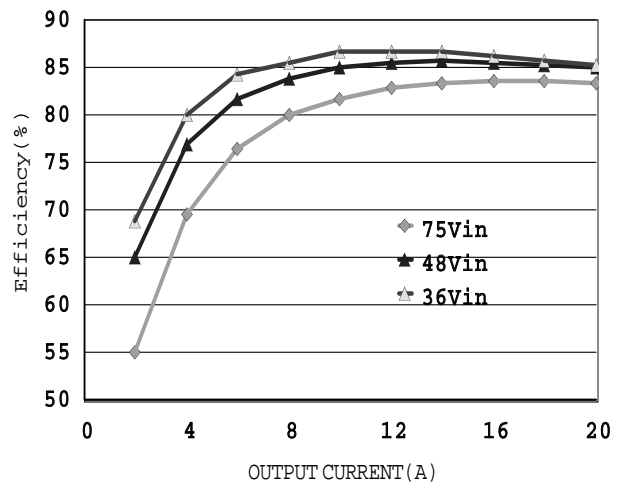

AV45C Quarter-Brick Series 100W Power Converters
36Vdc to 75Vdc Input, Single Output

Characteristic Curves (at 25 °C)

Typical Output Overcurrent Characteristics
AV45C-048L-050F20HAN

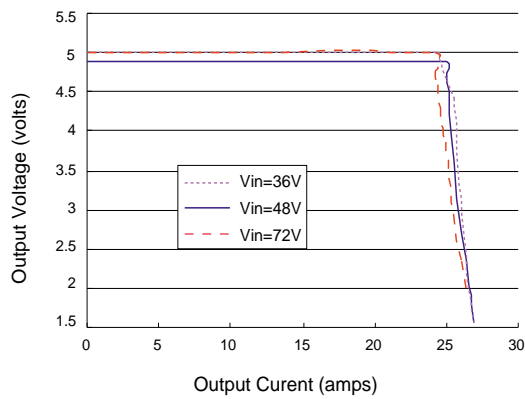

Typical Output Overcurrent Characteristics
AV45C-048L-018F20HAN

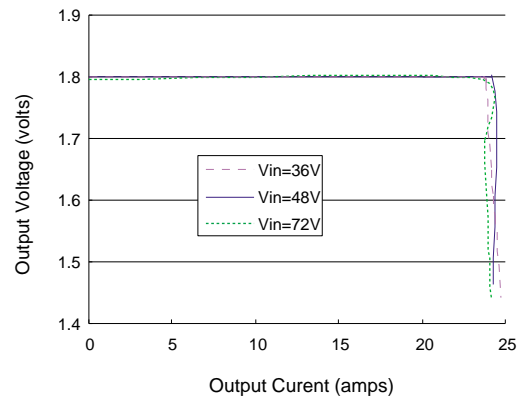

AV45C Quarter-Brick Series 100W Power Converters
36Vdc to 75Vdc Input, Single Output

Transient response (48V rated input voltage, full load, at 25 °C)

Typical Transient Response to Step Load Change from 50%-75%-50%I_{omax}, AV45C-048L-050F20HAN

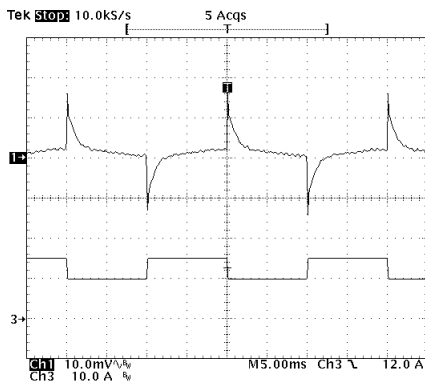

Typical Transient Response to Step Load Change from 75%-50%I_{omax}, AV45C-048L-050F20HAN

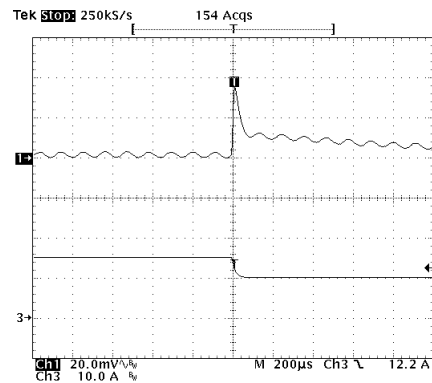

Typical Transient Response to Step Load Change from 50%-75%I_{omax}, AV45C-048L-050F20HAN

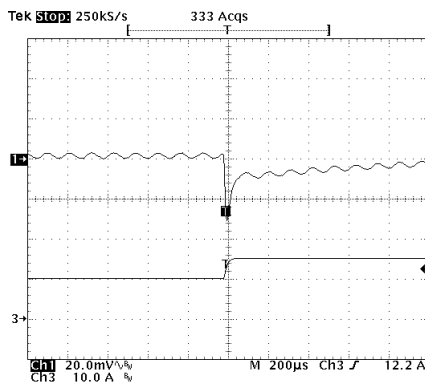

Typical Transient Response to Step Load Change from 50%-75%-50%I_{omax}, AV45C-048L-018F20HAN

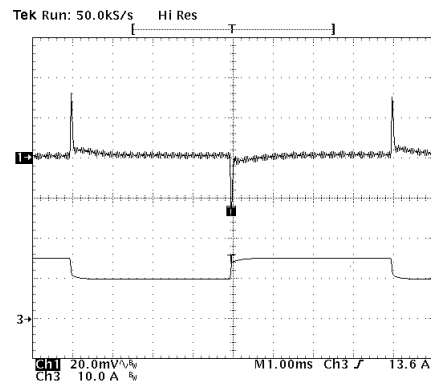

Typical Transient Response to Step Load Change from 75%-50%I_{omax}, AV45C-048L-018F20HAN

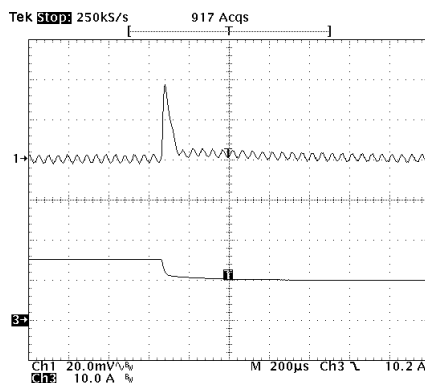

Typical Transient Response to Step Load Change from 50%-75%I_{omax}, AV45C-048L-018F20HAN

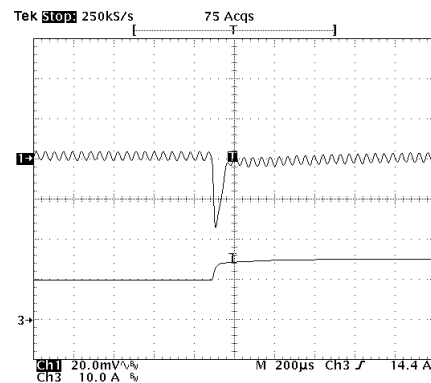

**AV45C Quarter-Brick Series 100W Power Converters
36Vdc to 75Vdc Input, Single Output**

Characteristic Curves (48V rated input voltage, full load, at 25 °C)

**Typical Start-Up from Power On
AV45C-048L-050F20HAN**

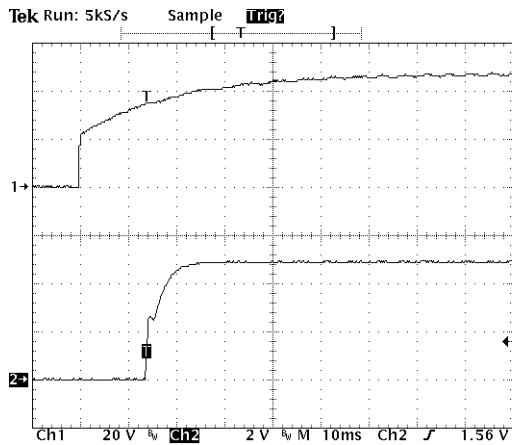

**Typical Start-Up from Power On
AV45C-048L-018F20HAN**

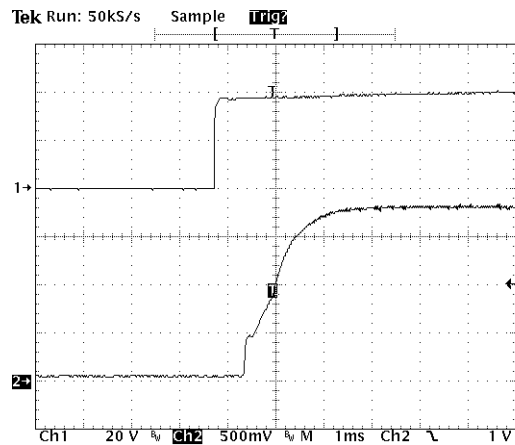

**Typical Shut-down from Power Off
AV45C-048L-050F20HAN**

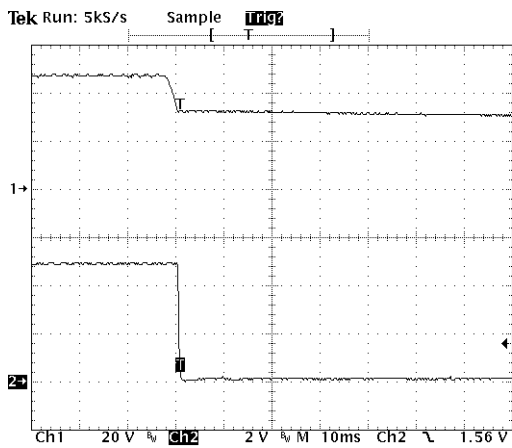

**Typical Shut-down from Power Off
AV45C-048L-018F20HAN**

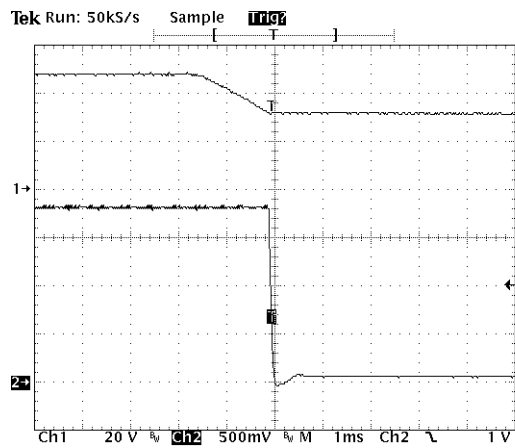

AV45C Quarter-Brick Series 100W Power Converters
36Vdc to 75Vdc Input, Single Output

Characteristic Curves (48V rated input voltage, full load, at 25 °C)

Typical Start-Up Transient with CNT
AV45C-048L-050F20HAN

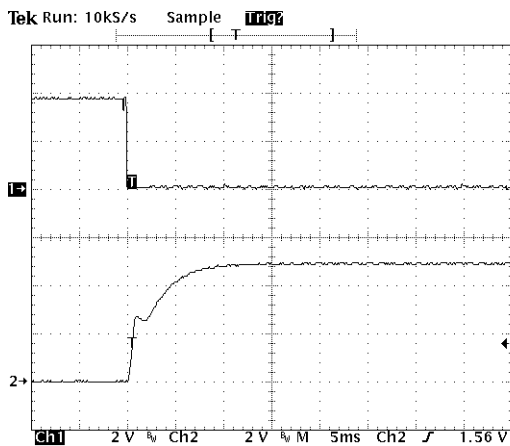

Typical Start-Up Transient with CNT
AV45C-048L-018F20HAN

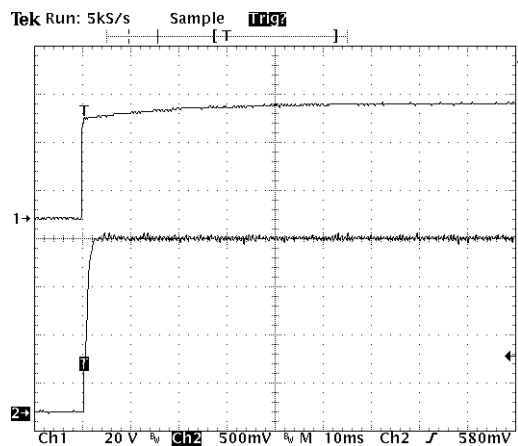

Typical Shut-down Transient with CNT
AV45C-048L-050F20HAN

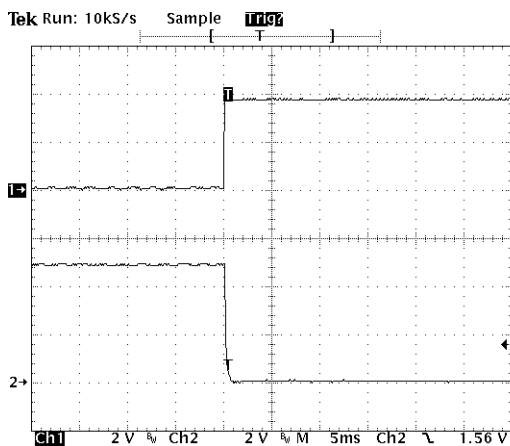

Typical Shut-down Transient with CNT
AV45C-048L-018F20HAN

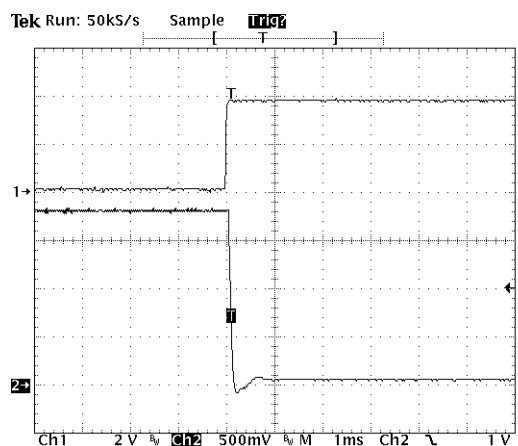

**AV45C Quarter-Brick Series 100W Power Converters
36Vdc to 75Vdc Input, Single Output**

Characteristic Curves (48V rated input voltage, full load, at 25 °C)

**Typical Output Ripple Voltage
AV45C-048L-050F20HAN**

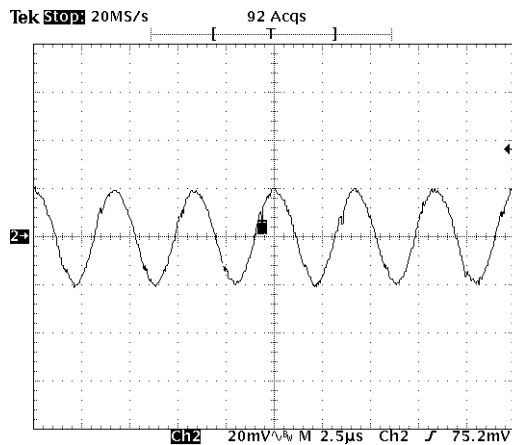

**Typical Output Ripple Voltage
AV45C-048L-018F20HAN**

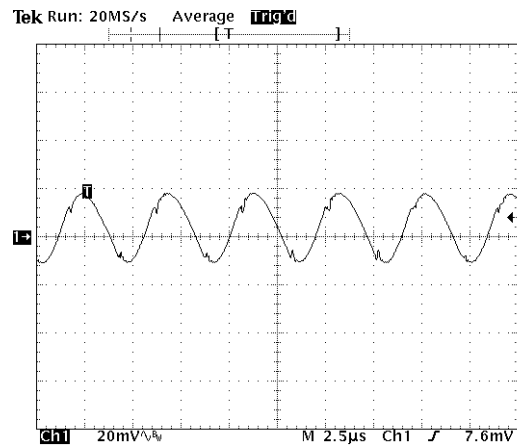

**Overvoltage Protection
AV45C-048L-050F20HAN**

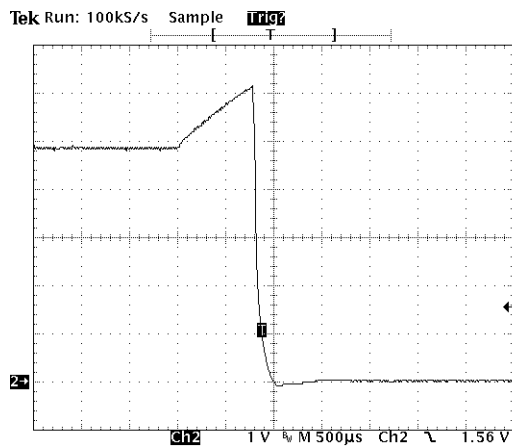

**Overvoltage Protection
AV45C-048L-018F20HAN**

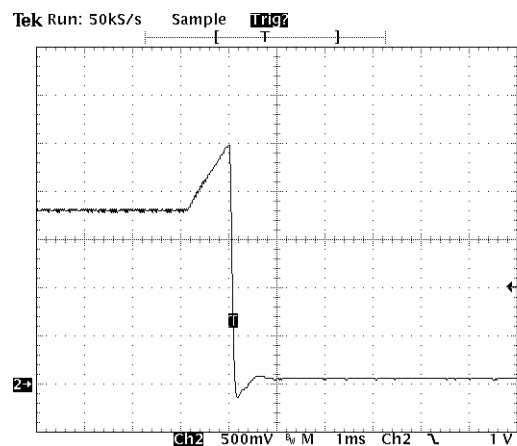

Pin Location

The +Vin and -Vin input connection pins are located as shown in Figure 1. AV45C series converters have a 2:1 input voltage range and can accept 36-75 Vdc input.

Care should be taken to avoid applying reverse polarity to the input which can damage the converter.

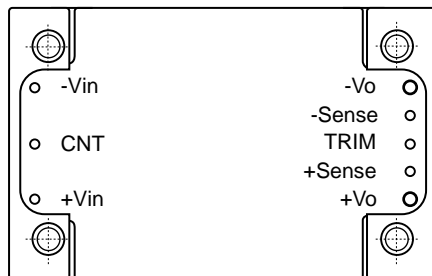

Fig.1 Pins Location (Pin-side View)

Input Characteristic

Fusing

The AV45C power module has no internal fuse. An external fuse must always be employed! To meet international safety requirements, a 250 Volt rated fuse should be used. If one of the input lines is connected to chassis ground, then the fuse must be placed in the other input line.

Standard safety agency regulations require input fusing. Recommended fuse ratings for the AV45C quarter-brick are shown in Table 1.

Table 1

Series	Fuse Rating(48Vin)
AV45C 5Vout	10A (Pout=100W)
AV45C 3.3Vout	8A (Pout=66W)
AV45C 1.8Vout	5A (Pout=36W)
AV45C 1.5Vout	5A (Pout=30W)

Note: the fuse is normal blow type.

Input Reverse Voltage Protection

Under installation and cabling conditions where reverse polarity across the input may occur, reverse polarity protection is recommended. Protection can easily be provided as shown in Figure 2. In both cases the diode rating is determined by the power of the converter.

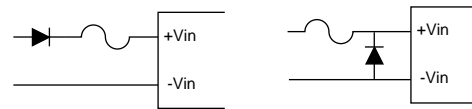

Fig.2 Reverse Polarity Protection Circuits

Placing the diode across the inputs rather than in-line with the input offers an advantage in that the diode only conducts in a reverse polarity condition, which increases circuit efficiency and thermal performance.

Input Undervoltage Protection

The AV45C quarter-brick series is protected against undervoltage on the input. If the input voltage drops below the acceptable range, the converter will shut down. It will automatically restart when the undervoltage condition is removed.

Input Filter

Input filters are included in the converters to help achieve standard system emissions certifications. Some users however, may find that additional input filtering is necessary. The AV45C quarter-brick series has an internal switching frequency of 250 kHz so a high frequency capacitor mounted close to the input terminals produces the best results. To reduce reflected noise, a capacitor can be added across the input as shown in Figure 3, forming

AV45C Quarter-Brick Series 100W Power Converters 36Vdc to 75Vdc Input, Single Output

a π filter. The recommended value of the capacitor C1 can refer to the **Typical Application** on page 3.

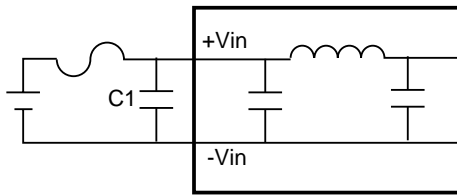

Fig.3 Ripple Rejection Input Filter

Also when a filter inductor is connected in series with the power converter input or when the input wiring is long (since the wiring can act as an inductor), an input capacitor C1 should be added. Failure to use an input capacitor under these conditions can produce large input voltage spikes and an unstable output.

For conditions where EMI is a concern, Figure 4 shows an input filter designed to reduce EMI effects.

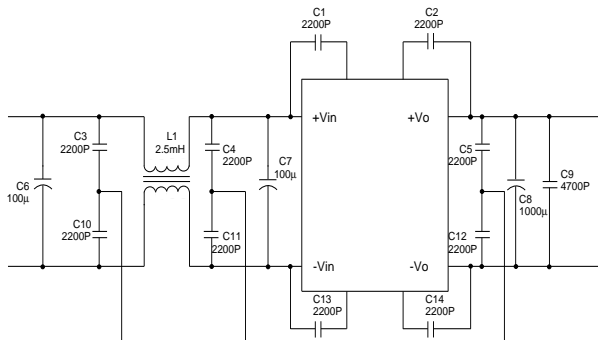

Fig.4 EMI Reduction Input Filter

CNT Function

Two CNT logic options are available. The CNT logic, CNT voltage and the module working state is as the following Table 2.

Table 2

	L	H	Open
N	ON	OFF	OFF
P	OFF	ON	ON

N--- means "Negative Logic"

P--- means "Positive Logic"

L--- means "Low Voltage", $-0.7V \leq L \leq 1.8V$

H--- means "High Voltage", $3.5V \leq H \leq 15V$

ON--- means "module is on"

OFF--- means "module is off"

Open--- means "CNT pin is left open"

Note: The $V_{CNT} \leq 15V$

The following figure 5 to 8 are a few simple CNT circuits.

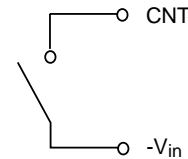

Fig.5 Simple CNT Control

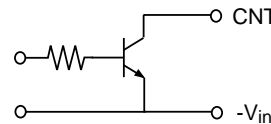

Fig.6 Transistor CNT Control

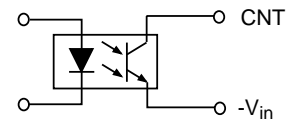

Fig.7 Isolated CNT Control

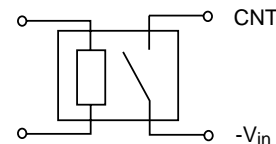

Fig.8 Relay CNT Control

Safety Consideration

For safety-agency approval of the system in which the power module is used, the power

AV45C Quarter-Brick Series 100W Power Converters 36Vdc to 75Vdc Input, Single Output

module must be installed in compliance with the spacing and separation requirements of the end-use safety agency standard, i.e., UL1950, CSA C22.2 No. 950-95, and EN60950. The input-to-output 1500VDC isolation is an operational insulation. The DC/DC power module should be installed in end-use equipment, in compliance with the requirements of the ultimate application, and is intended to be supplied by an isolated secondary circuit. When the supply to the DC/DC power module meets all the requirements for SELV(<60Vdc), the output is considered to remain within SELV limits (level 3). If connected to a 60Vdc power system, double or reinforced insulation must be provided in the power supply that isolates the input from any hazardous voltages, including the ac mains. One input pin and one output pin are to be grounded or both the input and output pins are to be kept floating. Single fault testing in the power supply must be performed in combination with the DC/DC power module to demonstrate that the output meets the requirement for SELV. The input pins of the module are not operator accessible.

Note: Do not ground either of the input pins of the module, without grounding one of the output pins. This may allow a non-SELV voltage to appear between the output pin and ground.

Output Characteristics

Minimum Load Requirement

There is no minimum load requirement for the AV45C quarter-brick series modules.

Remote Sensing

The AV45C quarter-brick series can remotely sense both lines of its output which moves the effective output voltage regulation point from

the output terminals of the unit to the point of connection of the remote sense pins. This feature automatically adjusts the real output voltage of the AV45C series in order to compensate for voltage drops in distribution and maintain a regulated voltage at the point of load.

When the converter is supporting loads far away, or is used with undersized cabling, significant voltage drop can occur at the load. The best defense against such drops is to locate the load close to the converter and to ensure adequately sized cabling is used. When this is not possible, the converter can compensate for a drop of up to 10% V_o , through use of the sense leads.

When used, the + and - Sense leads should be connected from the converter to the point of load as shown in Figure 9 using twisted pair wire. The converter will then regulate its output voltage at the point where the leads are connected. Care should be taken not to reverse the sense leads. If reversed, the converter will trigger OVP protection and turn off. When not used, the +Sense lead must be connected with + V_o , and -Sense with - V_o . Also note that the output voltage and the remote sense voltage offset must be less than the minimum overvoltage trip point.

Note that at elevated output voltages the maximum power rating of the module remains the same, and the output current capability will decrease correspondingly.

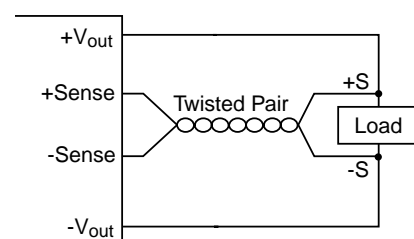

Fig.9 Sense Connections

AV45C Quarter-Brick Series 100W Power Converters 36Vdc to 75Vdc Input, Single Output

Output Trimming

Users can increase or decrease the output voltage set point of a module by connecting an external resistor between the TRIM pin and either the SENSE (+) or SENSE (-) pins. The trim resistor should be positioned close to the module. **If not using the trim feature, leave the TRIM pin open.**

Trimming up by more than 10% of the nominal output may damage the converter or trig the OVP protection. Trimming down more than 20% can cause the converter to regulate improperly. Trim down and trim up circuits and the corresponding configuration are shown in Figure 10 to Figure 14.

Note that at elevated output voltages the maximum power rating of the module remains the same, and the output current capability will decrease correspondingly.

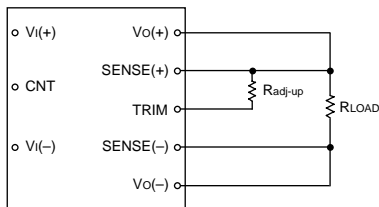

$$R_{adj-up} = \frac{5.1V_o(100+y)}{1.225y} - \frac{510}{y} - 10.2$$

where y is the adjusting percentage of the voltage.
 $0 < y < 10$
 R_{adj-up} is in k Ω .

Fig.10 Circuit Configuration and Equation to Trim Up Output Voltage

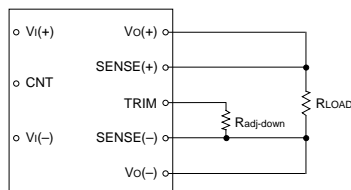

$$R_{adj-down} = \frac{510}{y} - 10.2$$

$0 < y < 20$
 where y is the adjusting percentage of the voltage.
 $R_{adj-down}$ is in k Ω .

Fig.11 Circuit Configuration and Equation to Trim Down Output Voltage

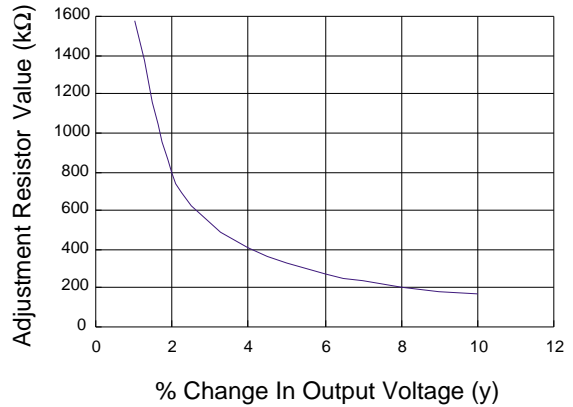

Fig.12 Resistor Selection for 5Vout Trimming Up

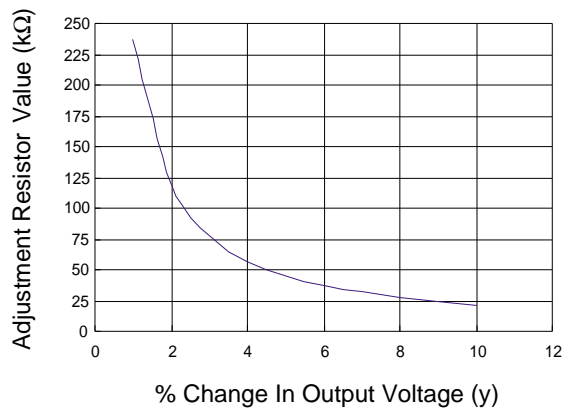

Fig.13 Resistor Selection for 1.8Vout Trimming Up

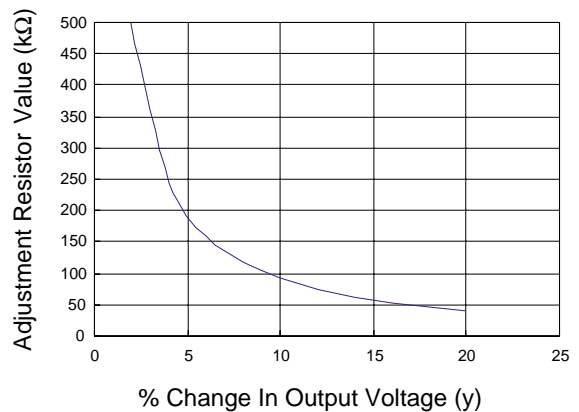

Fig.14 Resistor Selection for Trimming Down Output

AV45C Quarter-Brick Series 100W Power Converters 36Vdc to 75Vdc Input, Single Output

Output Over-Current Protection

AV45C quarter-brick series DC/DC converters feature foldback current limiting as part of their Overcurrent Protection (OCP) circuits. When output current exceeds 110 to 140% of rated current, such as during a short circuit condition, the output will shutdown immediately, and can tolerate short circuit conditions indefinitely. When the overcurrent condition is removed, the converter will automatically restart.

Output Filters

When the load is sensitive to ripple and noise, an output filter can be added to minimize the effects. A simple output filter to reduce output ripple and noise can be made by connecting a capacitor across the output as shown in Figure 15. The recommended value for the output capacitor C1 is 2200 μ F/10V (refer to page 3).

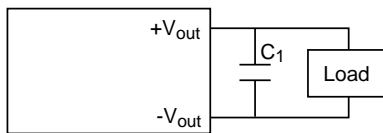

Fig.15 Output Ripple Filter

Extra care should be taken when long leads or traces are used to provide power to the load. Long lead lengths increase the chance for noise to appear on the lines. Under these conditions C2 can be added across the load as shown in Figure 16. The recommended component for C2 is 2200 μ F/10V capacitor and connecting a 0.1 μ F ceramic capacitor C1 in parallel generally.

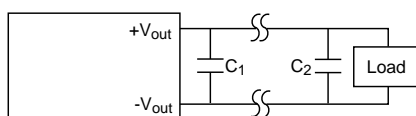

Fig.16 Output Ripple Filter For a Distant Load

Decoupling

Noise on the power distribution system is not always created by the converter. High speed analog or digital loads with dynamic power demands can cause noise to cross the power inductor back onto the input lines. Noise can be reduced by decoupling the load. In most cases, connecting a 10 μ F tantalum capacitor in parallel with a 0.1 μ F ceramic capacitor across the load will decouple it. The capacitors should be connected as close to the load as possible.

Ground Loops

Ground loops occur when different circuits are given multiple paths to common or earth ground, as shown in Figure 17. Multiple ground points can slightly different potential and cause current flow through the circuit from one point to another. This can result in additional noise in all the circuits. To eliminate the problem, circuits should be designed with a single ground connection as shown in Figure 18.

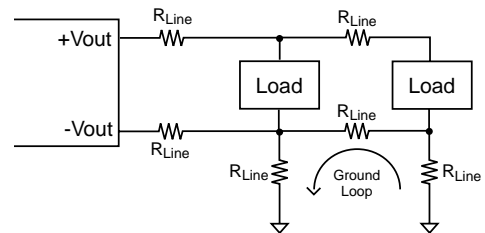

Fig.17 Ground Loops

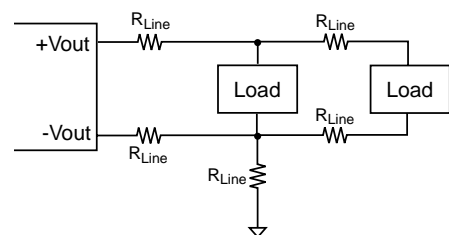

Fig.18 Single Point Ground

AV45C Quarter-Brick Series 100W Power Converters 36Vdc to 75Vdc Input, Single Output

Output Over-Voltage Protection

The over-voltage protection has a separate feedback loop which activates when the output voltage is between 5.7~6.8V (for 5V_{out}) and 2.2~2.8V (for 1.8V_{out}). When an over-voltage condition occurs, an internal “turn off” signal shut off the module. The module will restart after power on again.

Parallel Power Distribution

Figure 19 shows a typical parallel power distribution design. Such designs, sometimes called daisy chains, can be used for very low output currents, but are not normally recommended. The voltage across loads far from the source can vary greatly depending on the IR drops along the leads and changes in the loads closer to the source. Dynamic load conditions increase the potential problems.

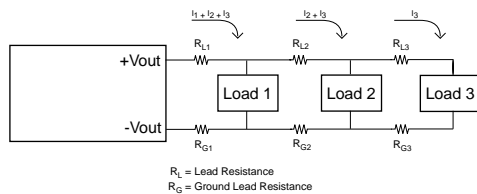

Fig.19 Parallel Power Distribution

Radial Power Distribution

Radial power distribution is the preferred method of providing power to the load. Figure 20 shows how individual loads are connected directly to the power source. This arrangement requires additional power leads, but it avoids the voltage variation problems associated with the parallel power distribution technique.

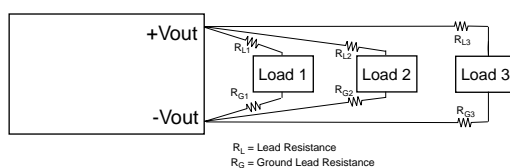

Fig.20 Radial Power Distribution

Mixed Distribution

In the real world a combination of parallel and radial power distribution is often used. Dynamic and high current loads are connected using a radial design, while static and low current loads can be connected in parallel. This combined approach minimizes the drawbacks of a parallel design when a purely radial design is not feasible.

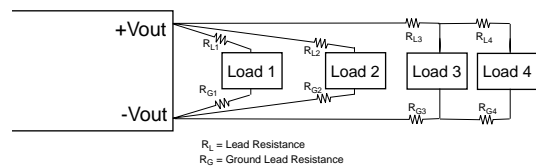

Fig.21 Mixed Power Distribution

Redundant Operation

A common requirement in high reliability systems is to provide redundant power supplies. The easiest way to do this is to place two converters in parallel, providing fault tolerance but not load sharing. Oring diodes should be used to ensure that failure of one converter will not cause failure of the other converter. Figure 22 shows such an arrangement. Upon application of power, one of the converters will provide a slightly higher output voltage and will support the full load demand. The second converter will see a zero load condition and will “idle”. If the first converter should fail, the second converter will support the most load. When designing redundant converter circuits, Shottky diodes should be used to minimize the forward voltage drop. The voltage drop across the Shottky diodes must also be considered when determining load voltage requirements.

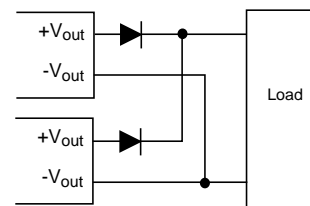

Fig.22 Redundant Operation

AV45C Quarter-brick Series Mechanical Considerations

Installation

Although AV45C quarter-brick series converters can be mounted in any orientation, free air-flowing must be taken. Normally power components are always put at the end of the airflow path or have the separate airflow paths. This can keep other system equipment cooler and increase component life spans.

Soldering

AV45C quarter-brick series is compatible with standard wave soldering techniques. When wave soldering, the converter pins should be preheated for 20-30 seconds at 110°C, and wave soldered at 260°C for less than 10 seconds.

When hand soldering, the iron temperature should be maintained at 425°C and applied to the converter pins for less than 5 seconds. Longer exposure can cause internal damage to the converter. Cleaning can be performed with cleaning solvent IPA or with water.

AV45C Hole Pattern

Component-side footprint.

Dimensions are in millimeters and (inches).

Fig. 23 is mechanical chart.

Fig. 24 is hole pattern.

MTBF

The MTBF, calculated in accordance with Bellcore TR-NWT-000332 is 2,000,000 hours. Obtaining this MTBF in practice is entirely possible. Mounting the modules in the well ventilated conditions or with heatsink on are expected to raise the MTBF.

ASTECC can offer custom thermal solutions.
Please contact the factory for details.

AV45C Quarter-Brick Series 100W Power Converters 36Vdc to 75Vdc Input, Single Output

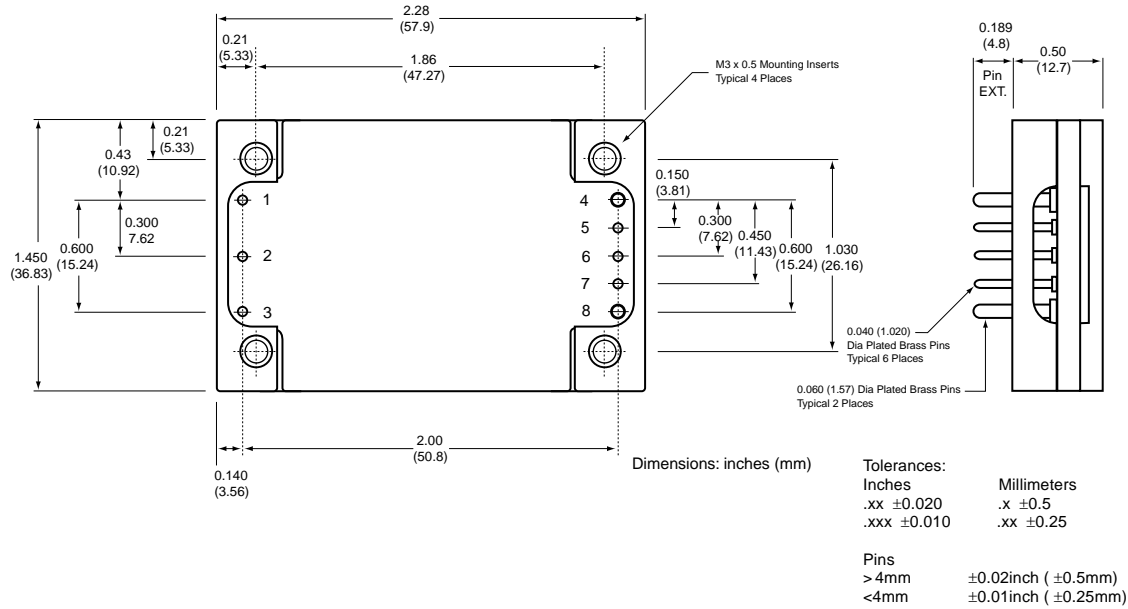

Pin	Function	Pin	Function
1	-Vin	4	-Vo
2	CNT	5	-Sense
3	+Vin	6	Trim
		7	+Sense
		8	+Vo

Fig.23 Mechanical Chart (Pin-side view)

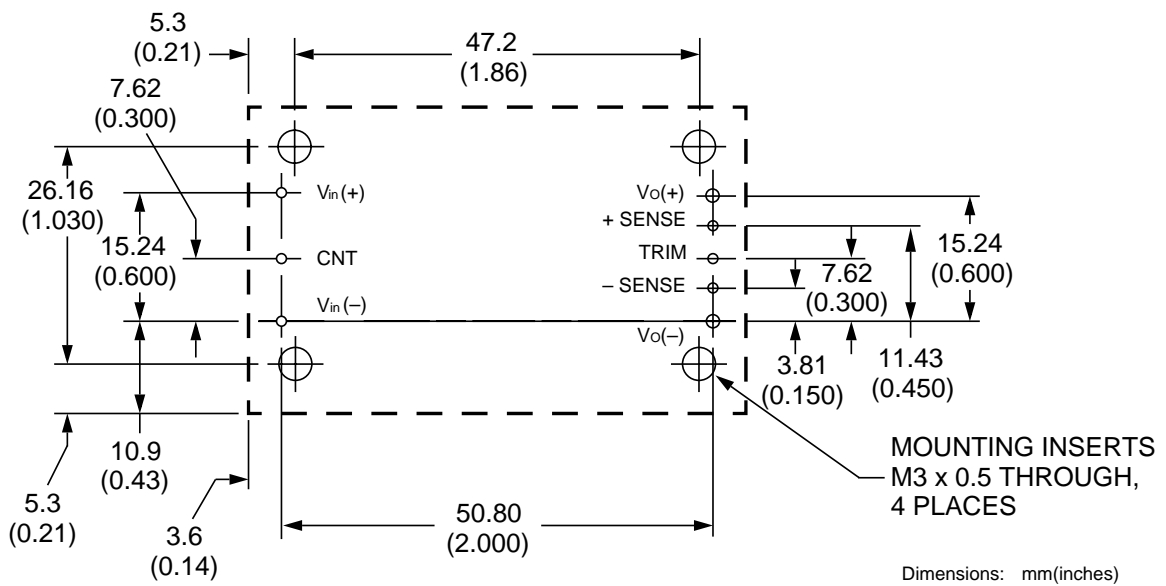
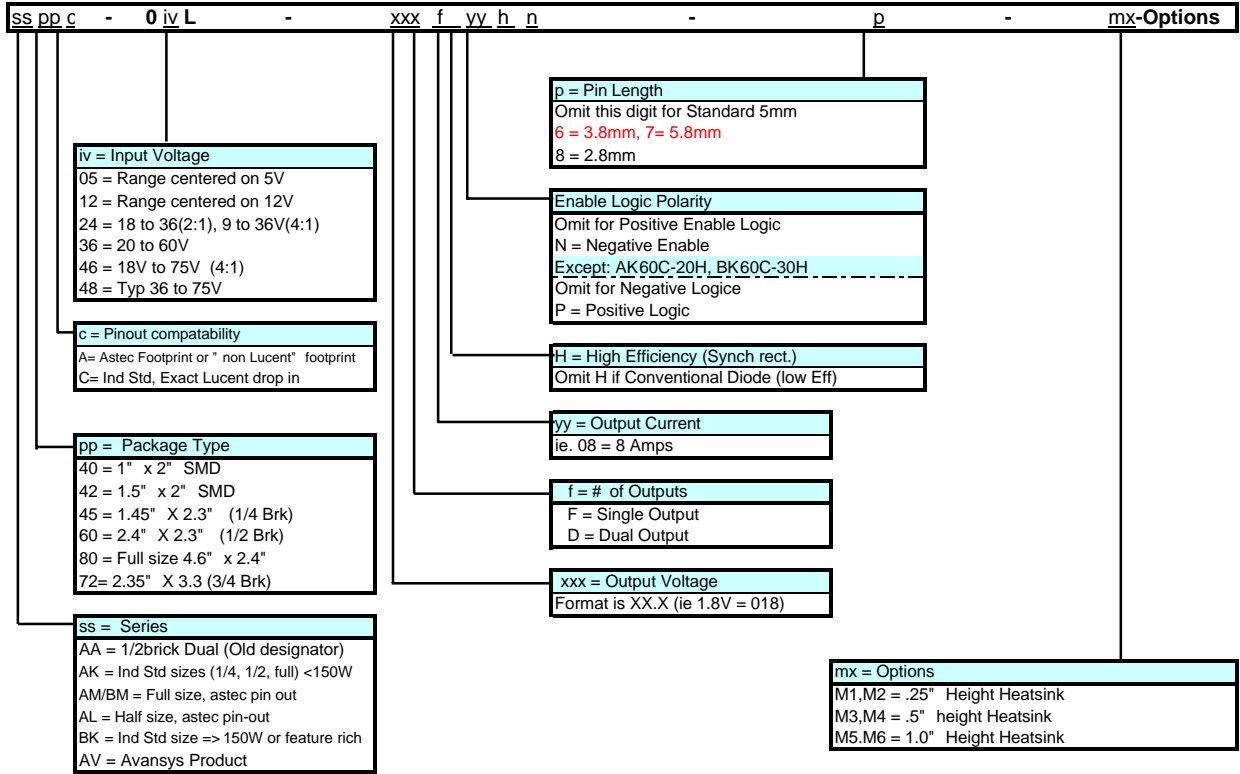

Fig.24 Hole Pattern (Base-plate side view)

PART NUMBER DESCRIPTION



Note: For some products, they may not conform with the PART NUMBER DESCRIPTION above absolutely.

NEW PART NUMBER DESCRIPTION

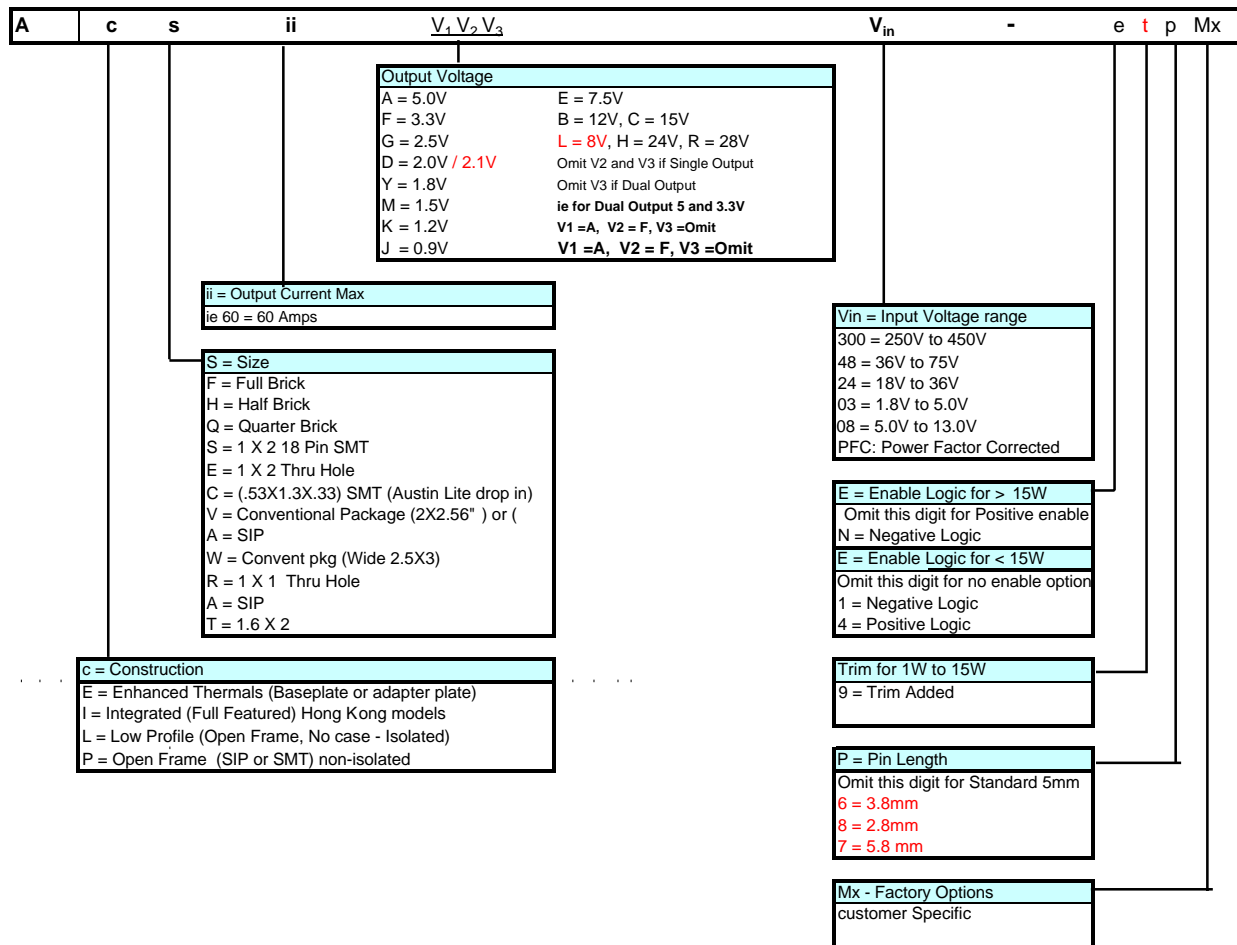

Note: For some products, they may not conform with the NEW PART NUMBER DESCRIPTION above absolutely.